

# Bungee Clamp Installation Instructions

Make the following modifications to your pole mount ends to allow the attachment of your new Bungee Clamps.

Use a 1/4" drill bit to drill the holes. You may want to drill the holes partially through from each side to prevent the wood from splintering on the back side when the drill bit pushes through.

The slots can easily be created with a hand saw.

You may adjust the tension on your bungee clamps by tying a knot on the end of the bungee cord. This method of adjustment doesn't require the slots to be cut, but the holes are still required.

Note: The bungee clamps should be positioned in-line with the fabric

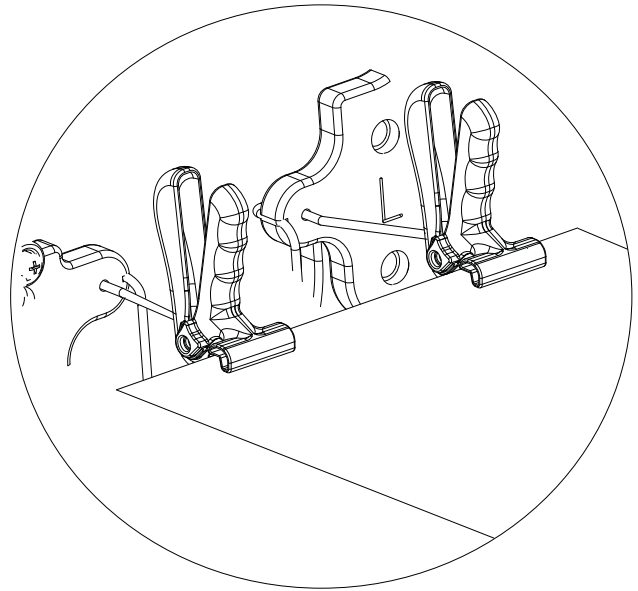
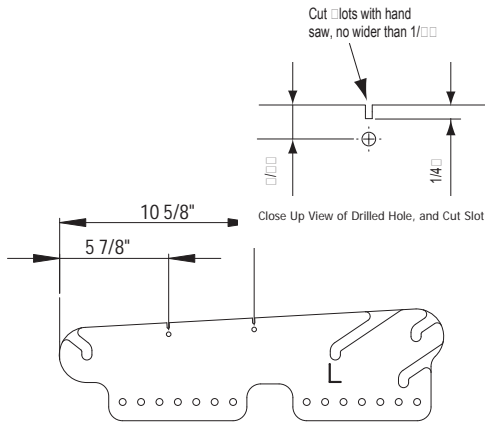

Bungee Clamp Attachment

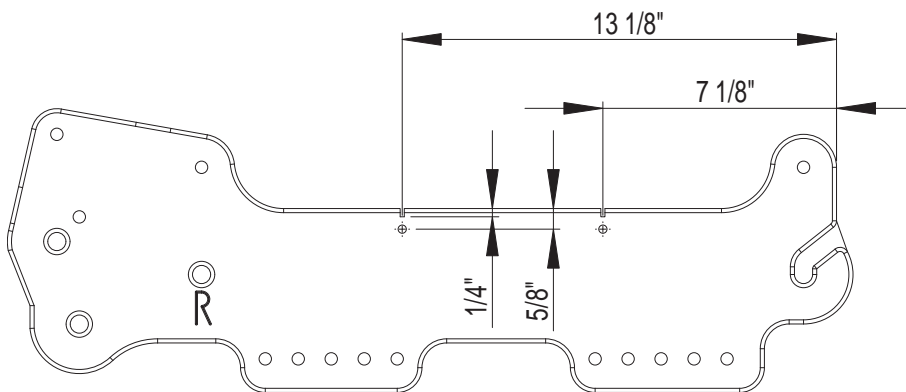
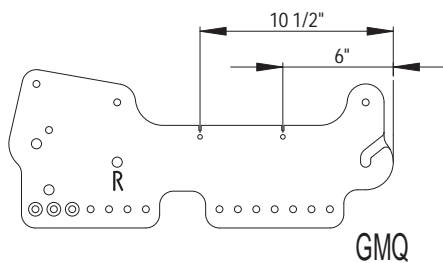

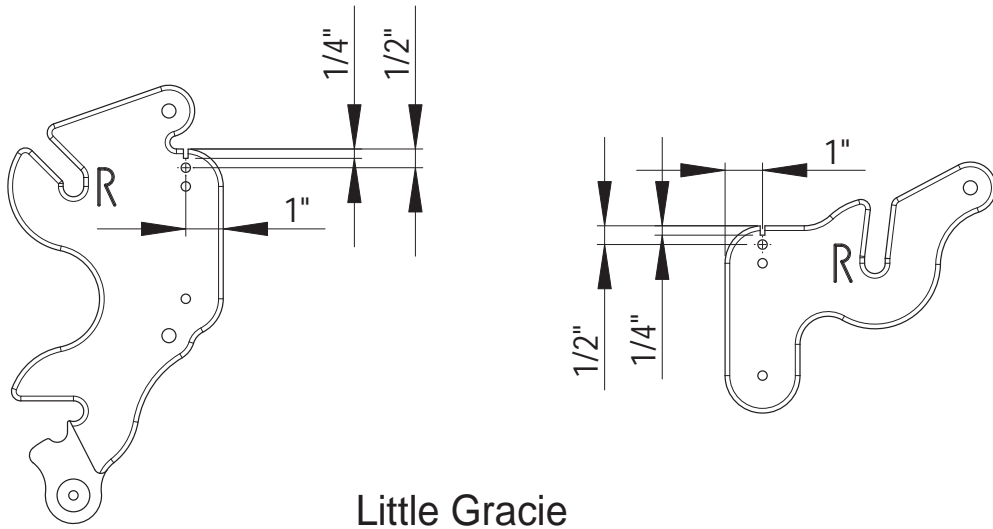

Little Gracie

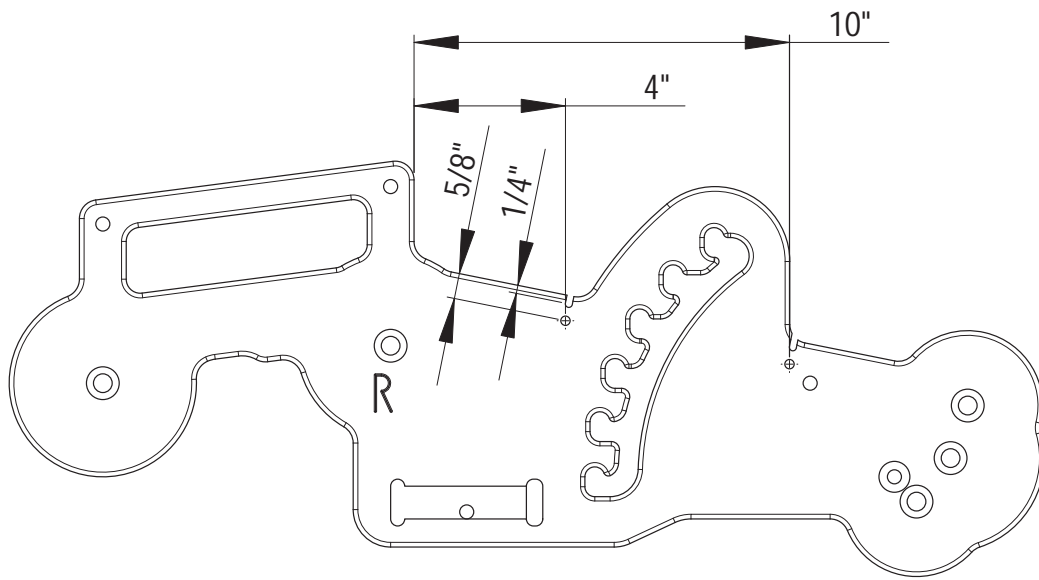

Z44

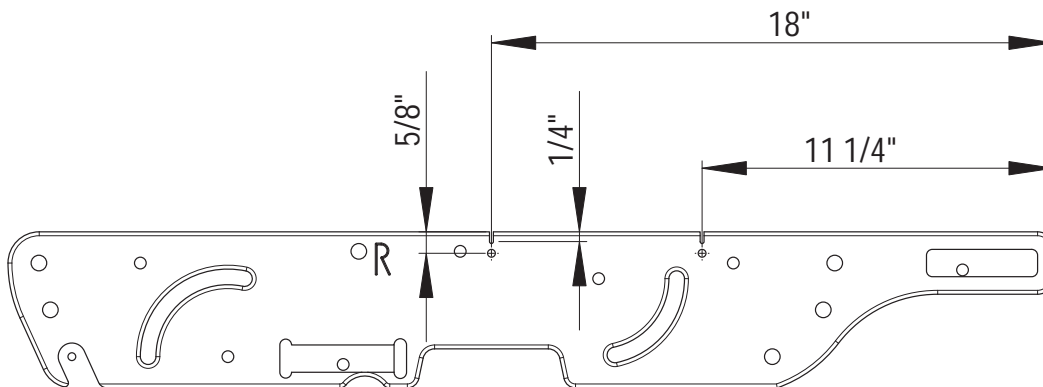

A34