

Quilting Machine Cover



Materials

- 2¾ yards total for cover
- 2¾ yards total for lining
- 3 yards batting
- Optional: Interfacing

Notes

- LOM=length of machine
- Use a ¼" seam allowance

Find the Length of Machine

For this pattern you will use a different measurement for your different machine. Use the chart below to determine the length of machine or LOM for your machine.

Machine Style	LOM
Q'nique 21 Series	40
Q'nique 19 Series	36
Q'nique 16 Series	34
Q'nique 15 Series	32

Sew the Sides of Your Cover

- Cut or piece fabric to create 2 sides and a top for your cover that are each 18in by LOM

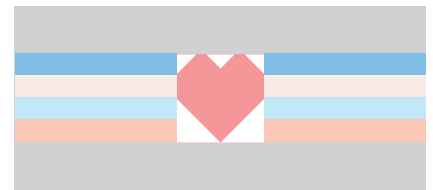
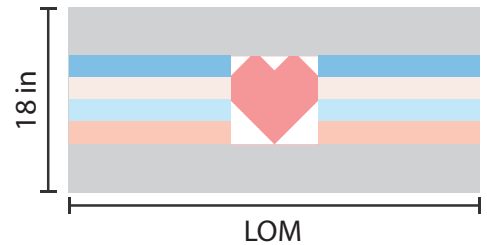

- Sew the top edge of the sides to either long edge of the top of your cover.

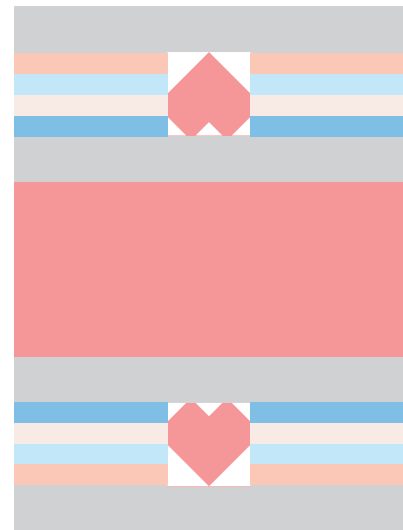

- Layer on some batting and quilt as desired.

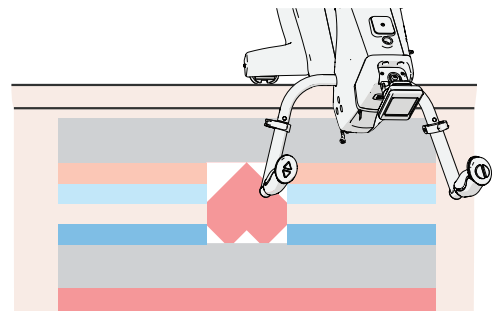

Grace Education

- Cut or piece 2 rectangles 20in x 18in for the front and back.

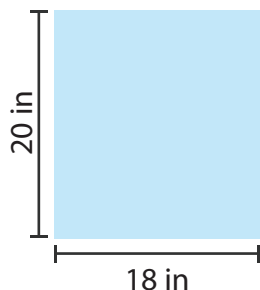

Make 2

- Use a plate or bowl to mark and cut rounded corners at the top of both your front and back.

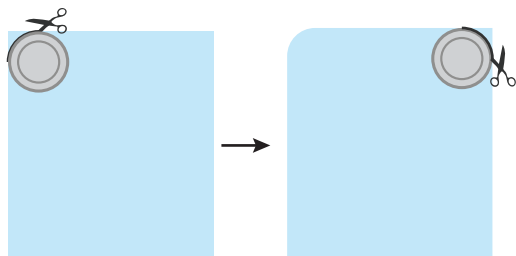

Make 2

- Layer both pieces on some batting and quilt as desired.

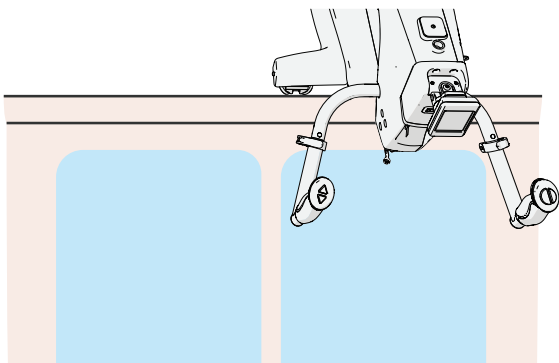

- Trim off the extra batting and pin the front and back pieces to the top and sides wrong sides facing out. Then stitch the edges with the wrong sides facing out.

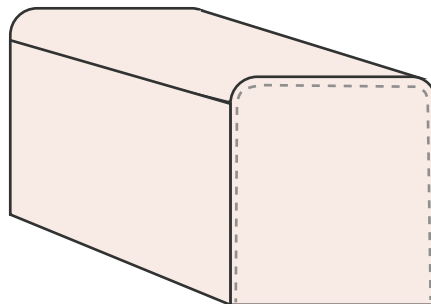

Sew your Lining

- Cut or piece fabric to create 2 sides and a top for your cover that are each 18in by LOM. If you want to add interfacing to any of the sides, attach it to any of the tops or sides.

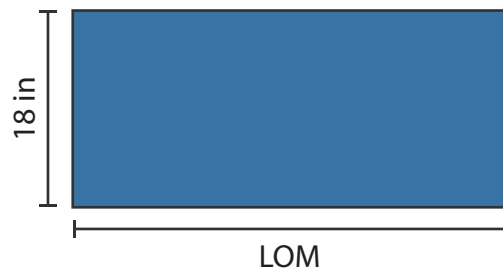

Make 3

- Sew the top edge of the sides to either long edge of the top of your cover.

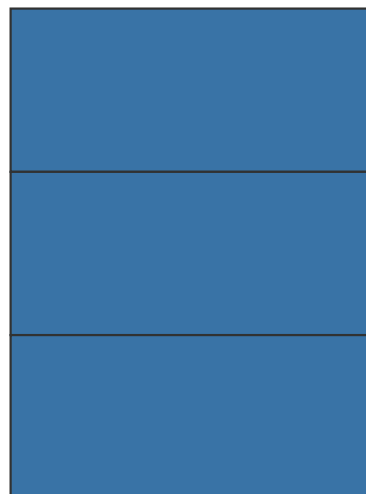

- Cut or piece 2 rectangles 20in x 18in for the front and back.

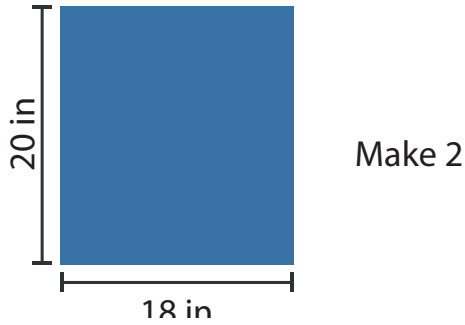

- Use a plate or bowl to mark and cut rounded corners at the top of both your front and back.

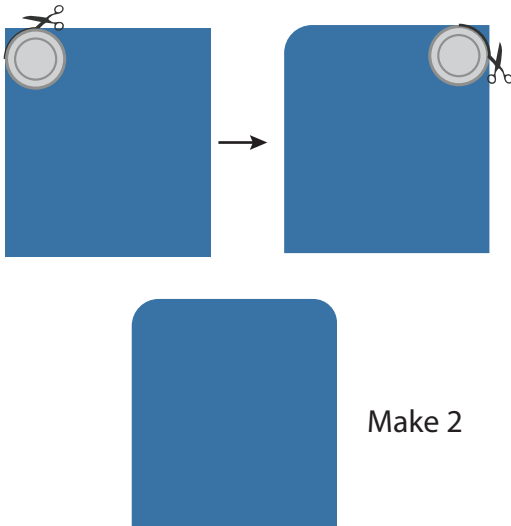

- Pin the front and back pieces to the top and sides wrong sides facing out. Then stitch the edges.

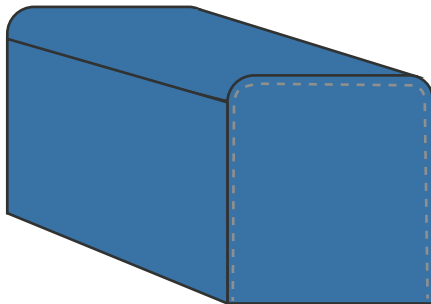

Join the Sides and the Lining

- Pin the corners of your outer sides and the lining of the quilt with the wrong sides out. Then sew around the edges, leaving an opening

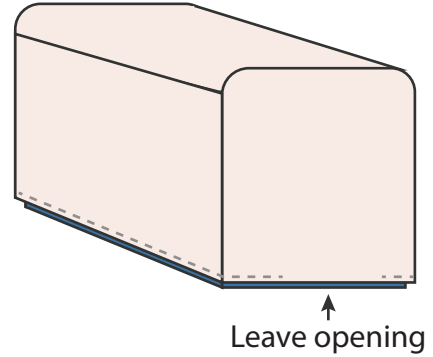

- Pull your cover right side out through the opening. Then stitch around the edge again to close the opening and finish off the edge

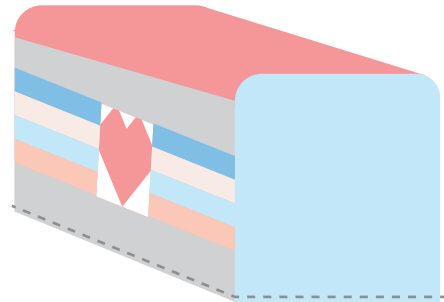

Grace Education

We hope you enjoy making this cover for your Q"nique Machine.

Celebrate and remember: we at The Grace Company provide you with the tools...you create the masterpiece!



Contact us!

Phone: (800) 264-0644

Email: education@graceframe.com

Web: www.graceframe.com



©The Grace Company
2225 South 3200 West
Salt Lake City, UT
84119 United States