

TrueCut™

EASY • SAFE • ACCURATE

My Comfort Cutter™

Pairs with
TrueCut rulers
for clean, straight
cuts!

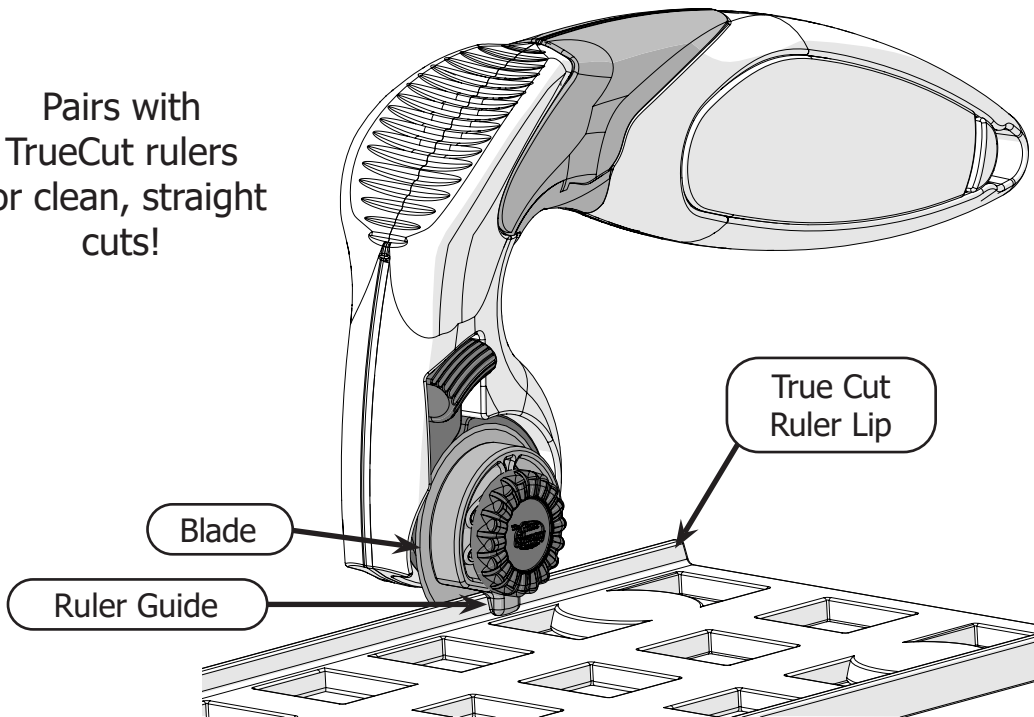

Included Parts

(Some parts pre-assembled)

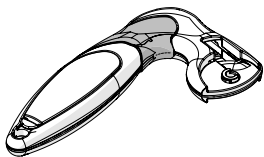

Ergo-Handle
TC-09-1598

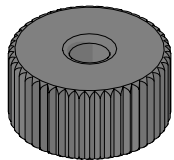

Nut
TC-05-1597

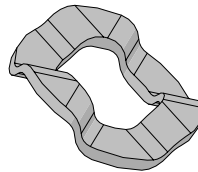

Spring
TC-03-1243

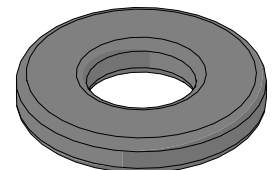

Plastic Washer
TC-05-1236

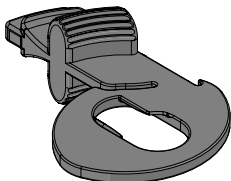

Blade Guard
TC-05-1239

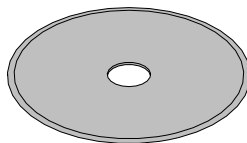

28 mm Blade
TC-08-1101

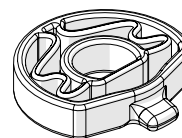

Ruler Guide
TC-05-1241

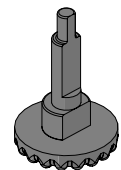

Guide Bolt
TC-05-1596

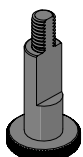

Bolt
TC-03-1556

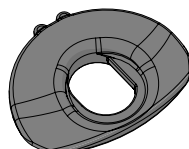

Plastic Insert
TC-05-1240

Grace
COMPANY

Parts

The cutter can be set up with or without the ruler guide and for right or left-handed use.

Pictured: Right-handed configuration using ruler guide.

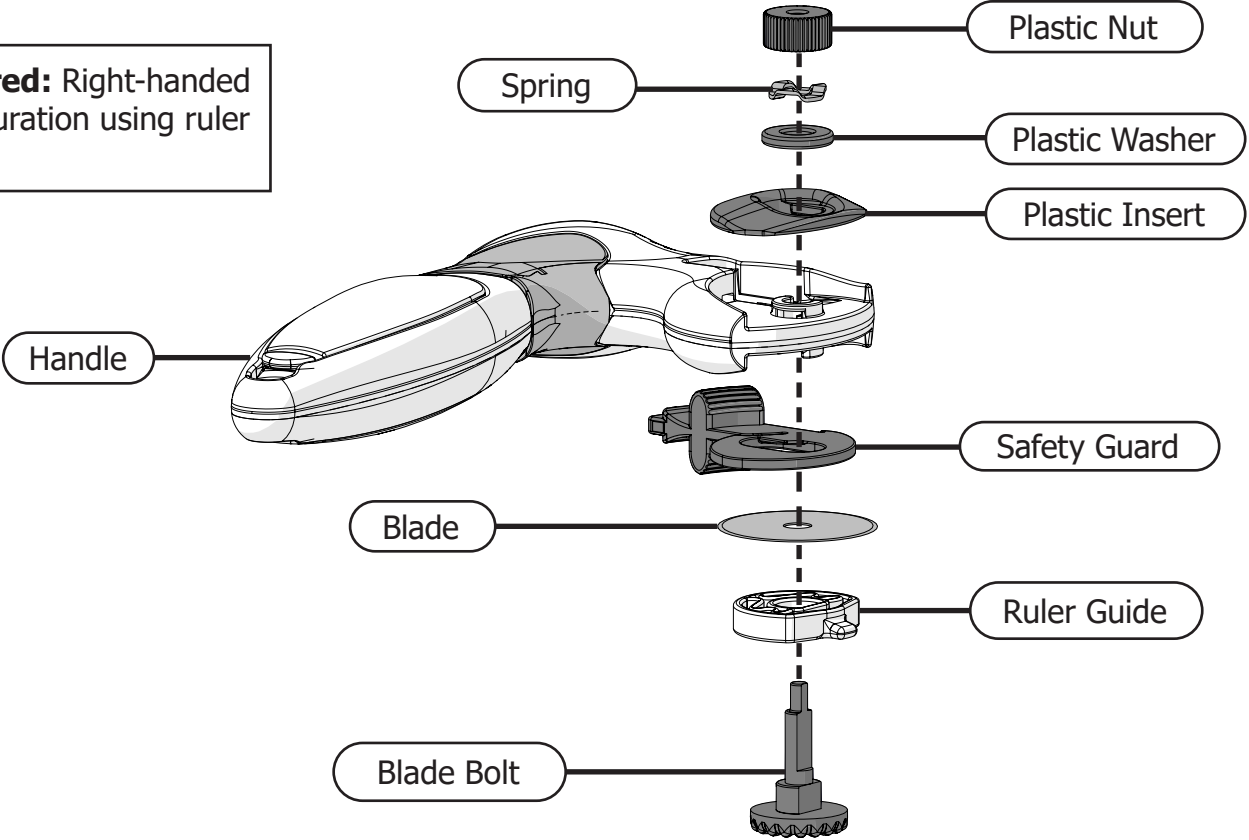

Pictured: Left-handed configuration without ruler guide.

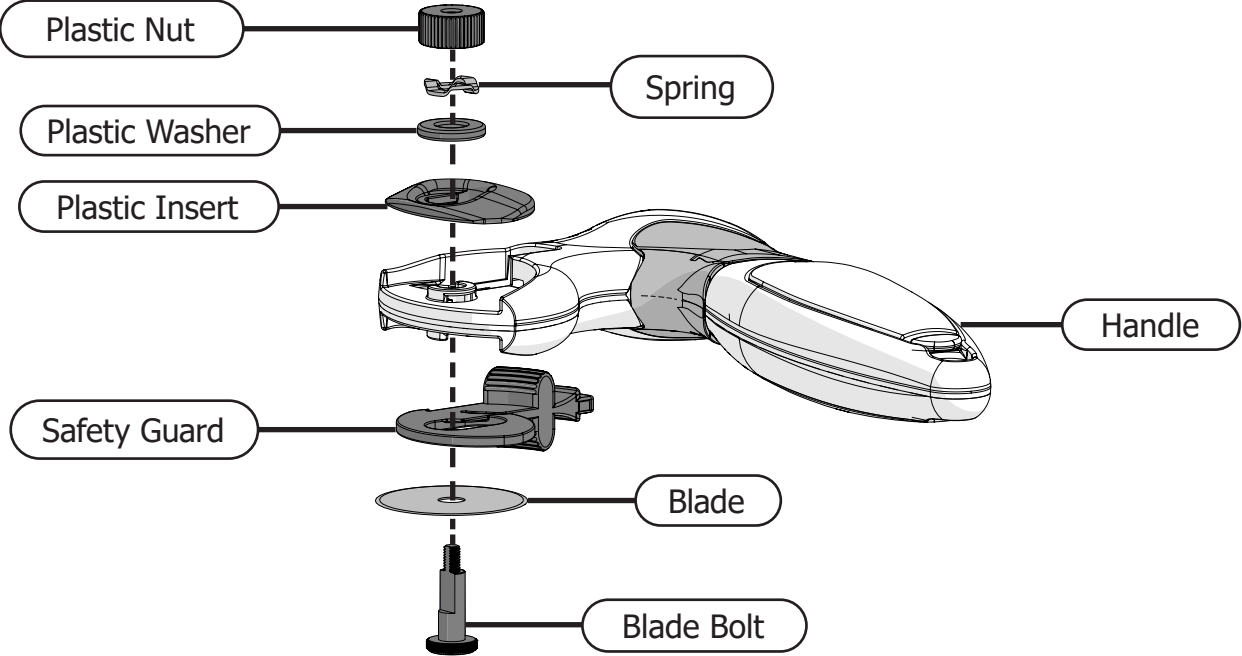

Changing the Blade

Take the following steps to change the blade on the cutter.

- 1 Remove the **plastic nut, spring, and plastic washer**.

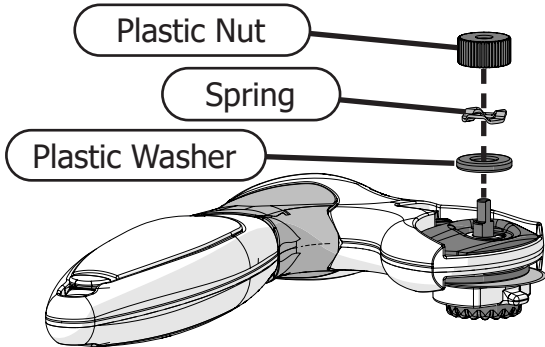

- 2 Push on the end of the **bolt** to remove the bolt, **blade**, and **ruler guide**.

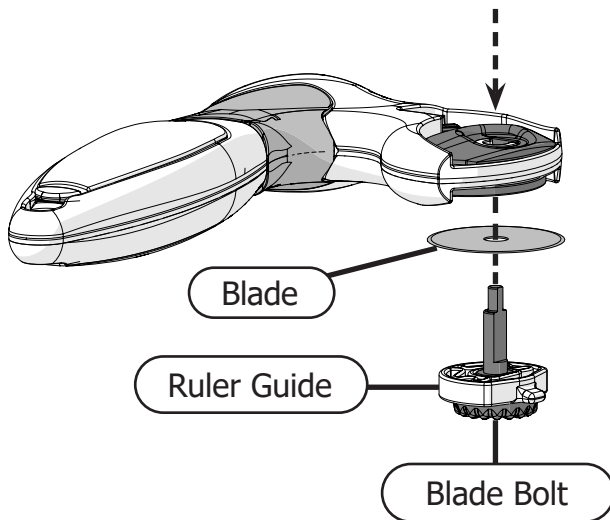

- 3 Reinstall the bolt and ruler guide with a **new or sharpened blade**.

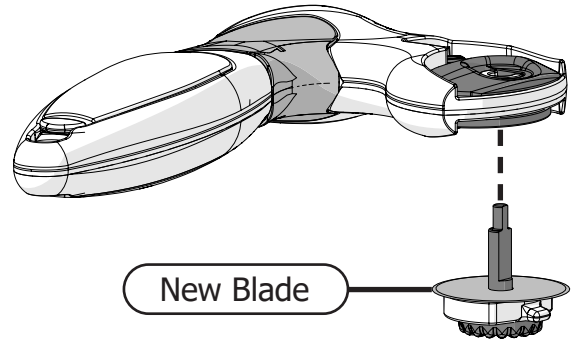

- 4 Reinstall the **plastic nut, spring, and plastic washer**.

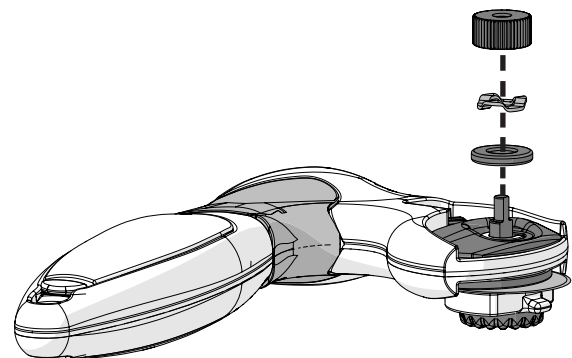

Swapping Hands

Take the following steps to switch the cutter from right-handed to left-handed.

- 1 Remove the **plastic nut, spring, and plastic washer**.

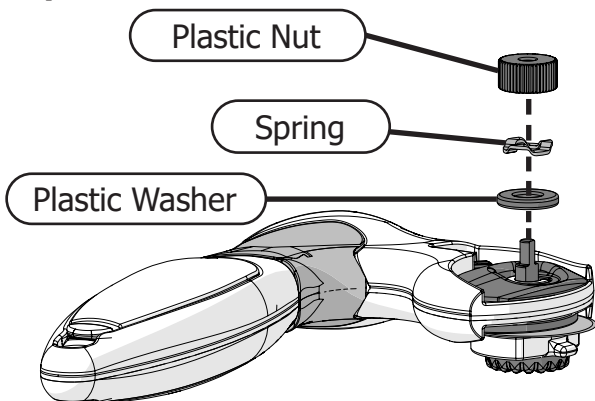

- 2 Push on the end of the **bolt** to remove the bolt, **blade**, and **ruler guide**.

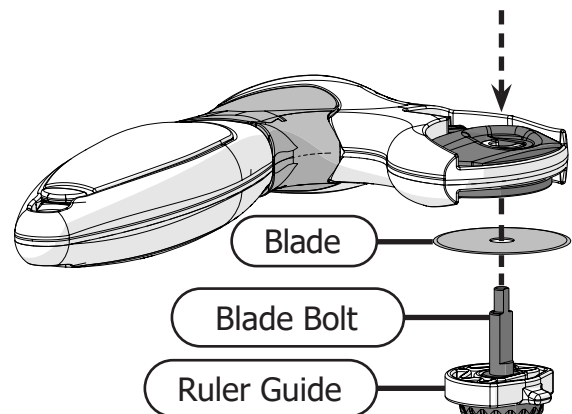

Swapping Hands (continued)

- 3 Remove the **safety guard** by pushing it back and then pulling it out.

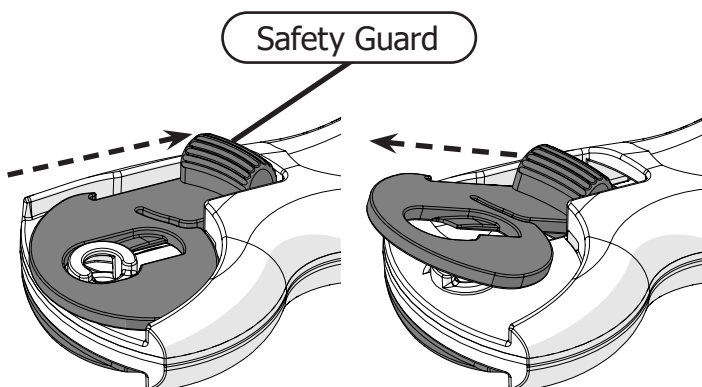

- 4 Remove the **right handle base** by pulling it out.

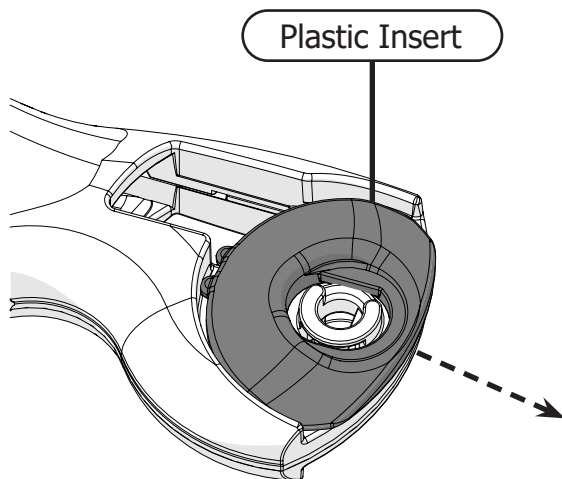

- 5 Install the right handle base on the left side of the cutter.

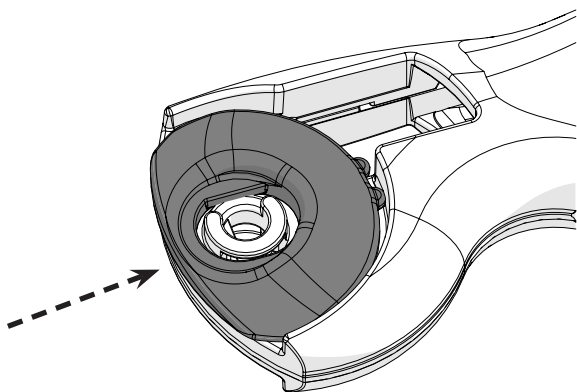

- 6 Reinstall the safety guard on the right side of the cutter by inserting it at an angle and then pulling it out.

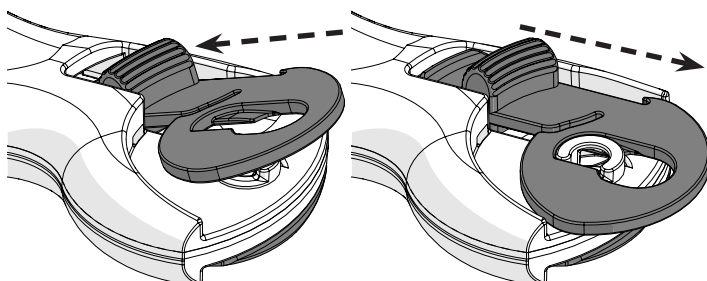

- 7 Reinstall the bolt, blade, and ruler guide so that they are on the right side of the cutter.

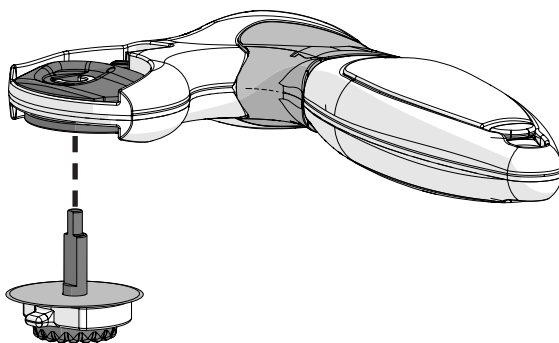

- 8 Reinstall the nut, spring, and washer so that they are on the left side of the cutter and tighten to hold in place.

