

Q'nique21 PRO

Thread Guide

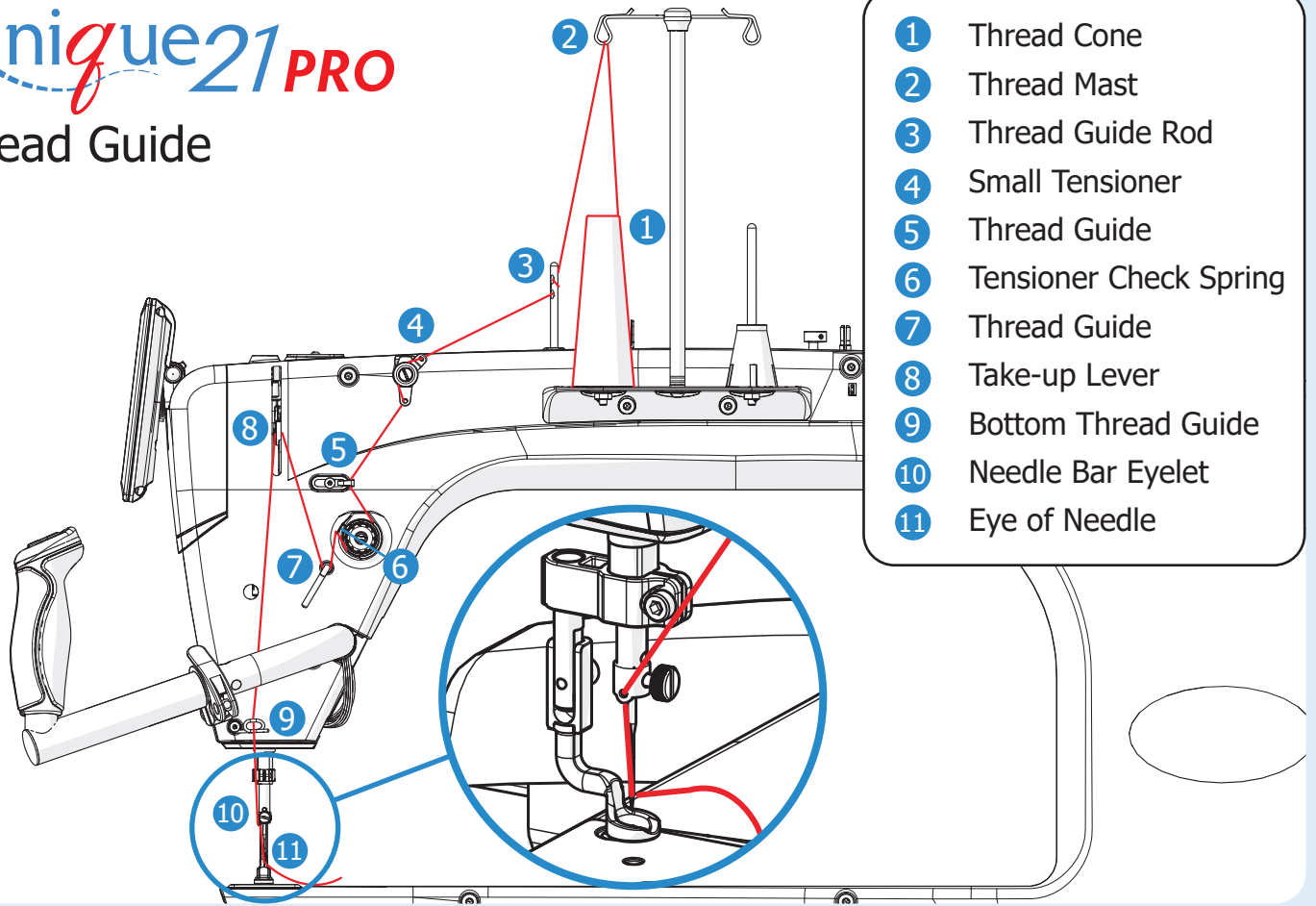

- 1 Thread Cone
- 2 Thread Mast
- 3 Thread Guide Rod
- 4 Small Tensioner
- 5 Thread Guide
- 6 Tensioner Check Spring
- 7 Thread Guide
- 8 Take-up Lever
- 9 Bottom Thread Guide
- 10 Needle Bar Eyelet
- 11 Eye of Needle

Troubleshooting

If your thread is breaking...

- Replace your needle if it is bent or burred. Use the needle magnet to install and align the needle.
- Follow the "Top Thread Tension" guide on the back to correct your thread tension.
- Check that your machine is threaded correctly using the "Thread Guide" above.
- Follow the "Bobbin Guide" on the back for threading, tensioning, and installing the bobbin case.

- Check the hopping foot height.
- Adjust the height of the take-up rail on your quilting frame to be 1/4 inch above the needle plate.
- For more help call 1(800) 264-0644 or e-mail support@graceframe.com.

If your machine is skipping stitches...

- Replace your needle if it is bent or burred. Use the needle magnet to align and install your needle straight.

- Follow the "Top Thread Tension" guide on the back to correct your thread tension.
- Check the hopping foot height.
- Adjust the height of the take-up rail on your quilting frame to be 1/4 inch above the needle plate.
- For more help call 1(800) 264-0644 or e-mail support@graceframe.com.

Needle Information

Needle Style: DPx5 MR, 134 MR, 1955 MR

Bobbin Type: M-Class

Use a straight needle.

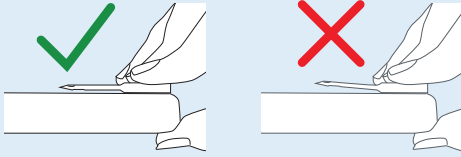

Size: Thread Size and Type:

14/90	mono-filament, 100 wt. silk, 60 wt. polyester
16/100	mono-filament, 60 wt., 50 wt. polyester or cotton thread
18/110	40 wt. cotton and polyester, 30 wt. cottons and polyester
20/125	any thread 30 wt. or heavier

Bobbin Guide

Place the bobbin in the bobbin case so that when you pull the thread, the bobbin rotates clockwise.

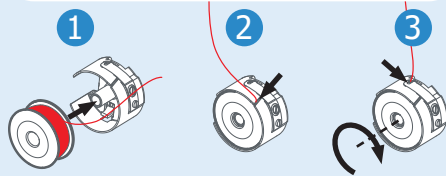

Tension Test: Hold the bobbin case in your hand and pull the thread up.

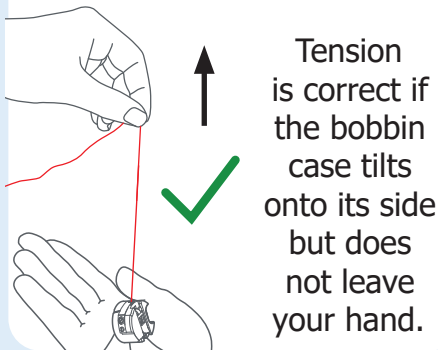

Tension is correct if the bobbin case tilts onto its side but does not leave your hand.

Set the bobbin tension first, and then adjust the top thread tension.

If the bobbin case does not tilt up...

Increase Tension by twisting the large bobbin case screw clockwise with a small screwdriver, pin or fingernail.

Large Screw

If the bobbin case leaves your hand...

Decrease Tension by twisting the large bobbin case screw counter-clockwise with a small screwdriver, pin or fingernail.

Large Screw

Top Thread Tension

Set the bobbin tension first (see above).

Correct thread tension
The top and bobbin thread knot in the middle of the fabric layers.

If the top thread is pulled through the bottom layer of fabric, increase tension.

If the bobbin thread is pulled through the top layer of fabric, decrease tension.

Sewing Button Controls

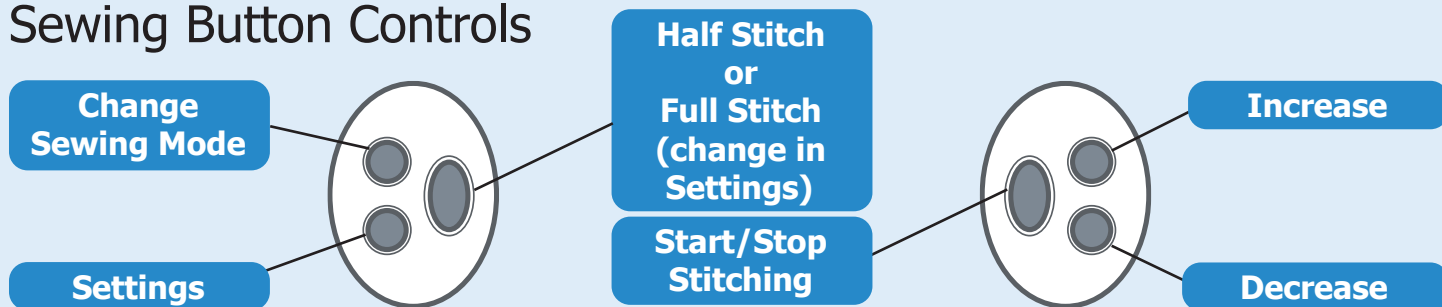

*Buttons are reversible in Settings for left-handed quilters.

Quilting Screen

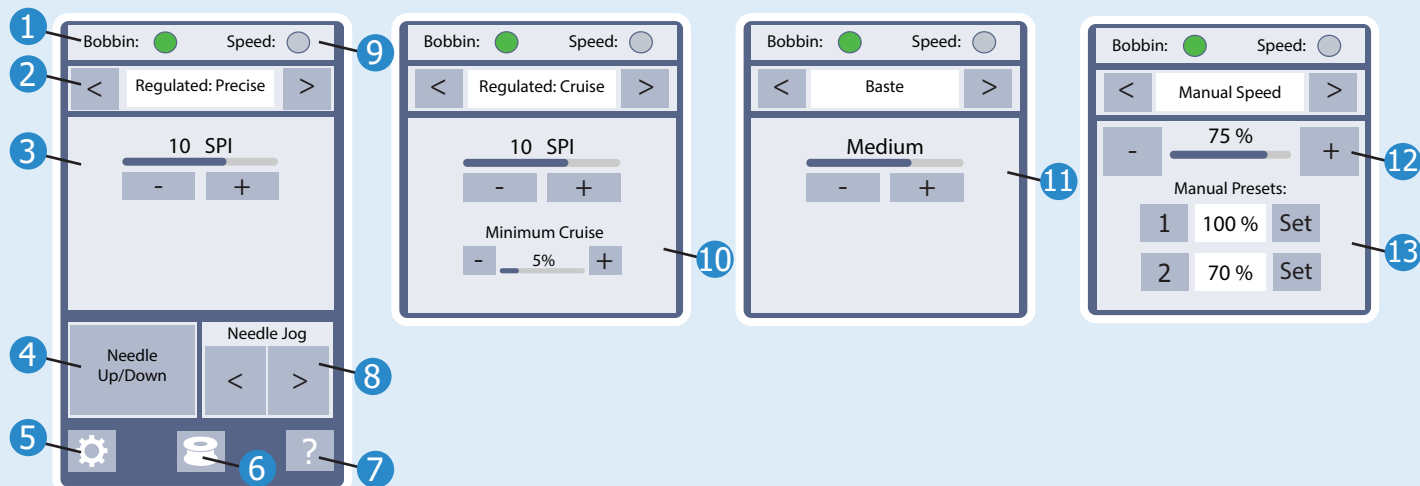

- 1 Bobbin Level Estimate**
Estimated bobbin fill level.
- Above 21%
 - Between 11–21%
 - Under 10%
- This can be disabled in Bobbin Estimator screen.

- 2 Sewing Mode**
Press [**<**] or [**>**] to switch to Precise, Cruise, Baste, and Manual.

- 3 Stitch Length**
Displayed in Stitches Per Inch (SPI) or Centimeter (SPC) (units can be changed in Settings). Press [**-**] to decrease SPI/SPC and [**+**] to increase SPI/SPC.

- 4 Full Stitch or Needle Up/Down**
Creates a full stitch or moves the needle up or down. This can be changed in Settings.

- 5 Settings**

- 6 Bobbin Estimator**

- 7 Help**

- 8 Jog Needle**
Press [**<**] or [**>**] to move the needle incrementally.

- 7 Over-speed Indicator.**
Icon will change [**Red**] if you move your machine faster than it is able to make even stitches.

- Stitching Inactive
- Good Speed
- Moving Too Fast

- 10 Minimum Speed**
Shown as a percentage of the machine's highest speed, ranging from 5% to 25%. Press [**-**] to decrease stitch speed and [**+**] to increase stitch speed.

- 11 Baste Length**
Press [**-**] to decrease stitch length and [**+**] to increase stitch length.

- 12 Manual Speed**
Displayed as a percentage of the highest speed. Press [**-**] to decrease speed and [**+**] to increase speed.

- 13 Manual Speed Presets**
Press to use that stitch speed. Press [**Set**] to update the preset speed to the current machine speed.

Settings Button Controls

All other buttons function only in the quilting screens.

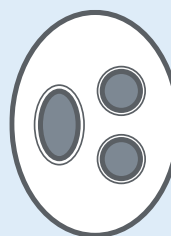
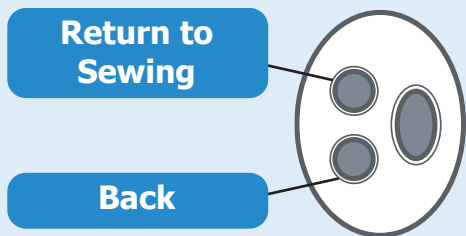

*Buttons are reversible in Settings for left-handed quilters.

Settings Screen

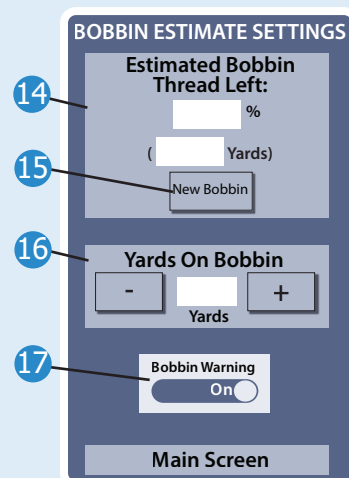
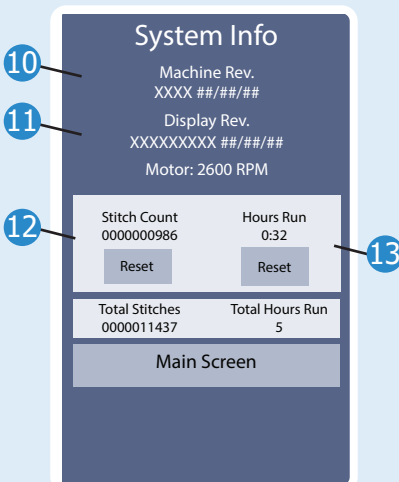
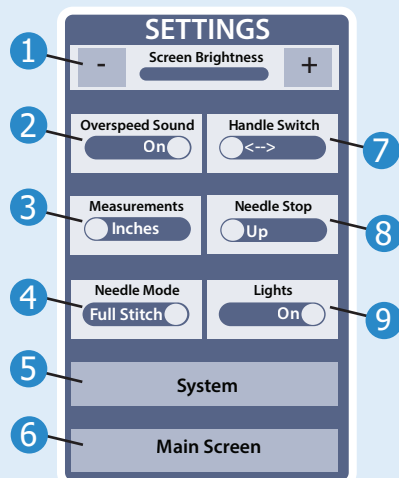

1 Screen Brightness
Press [-] to dim screen and [+] to lighten the screen.

2 Overspeed Sound
Press to mute the over-speed alarm.

3 Measurements
Change length units from SPI (inches) to SPC (metric) on the quilting screen.

4 Needle Mode
Switch between the full stitch and half stitch button on the quilting screen.

5 System Information

6 Return to Sewing

7 Handle Switch
Reverse the left and right handlebar controls. This is useful for left-handed quilters.

8 Needle Stop
Choose to have the needle stop in the [Up] or [Down] position when stitching is inactive.

9 Lights
Turns the lights over the needle plate on or off.

10 Machine Revision

11 Display Revision

12 Stitch Count
Press [Reset] to reset the stitch count. "Total Stitches" will not reset.

13 Hour Count
Press [Reset] to reset the hour count. "Total Hours Run" will not reset.

14 Estimated Bobbin Thread Left
Calculated percent and yardage of thread remaining.

15 New Bobbin
Resets calculation of bobbin thread.

16 Yards On Bobbin
Estimate the yards of thread on full bobbin. **Tip:** A fully wound M-class bobbin of 40 wt. cotton thread is approximately 90 yards.

17 Bobbin Warning
Displays or removes bobbin warning indicator in top left corner of each quilting mode screen.